

IMAGINE YOUR **DREAM WATERFRONT**



DOCKS • BOAT LIFTS • PWC LIFTS • KAYAK LAUNCHES • SWIM PLATFORMS • SLIDES

RESIDENTIAL EDITION



VERSATILE, DURABLE & CAREFREE

No two waterfront properties are exactly alike, so why not choose the versatility of the EZ Dock modular floating dock system that can be configured to meet your unique waterfront vision? When you finish your dock design, customize it with benches, a slide or storage. You can even add more dock pieces later or reconfigure the layout as your needs change. Exactly what you want, exactly how you want it. Why settle for anything less?



EZ DOCK ADVANTAGES



**NO WOOD
TO ROT**

MAINTENANCE-FREE & BAREFOOT FRIENDLY

EZ Dock's polyethylene docks are durable, slip-resistant, and completely wood-free. They won't splinter or rot, they never need painting, and there are no nails to come loose or rust. Just clean with soap and water from a garden hose and spend more time enjoying the water.



STABLE AND RUGGED

FLEXIBLE FLOTATION TECHNOLOGY

EZ Dock's marine-grade, polyethylene flotation chambers are constructed with extra-heavy and extra-thick walls to ensure optimal strength and structural integrity. The chambers (or pylons) are designed into our dock sections to provide additional stability on the water and allow the dock sections to adapt easily to changing water conditions and levels.

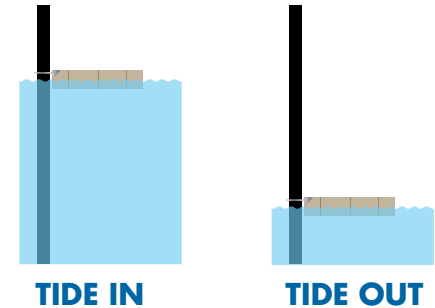

ADAPTABLE DESIGN

EZ Dock's boat lifts, PWC lifts and docks have a unique design that delivers outstanding load capacity, functionality and safety. A variety of dock sections and lifts, plus an extensive selection of anchoring systems and accessories, make it easy to customize your EZ Dock to make it the perfect waterfront retreat.

EASY TO BUILD & EASY TO CUSTOMIZE

EZ Dock's modular system lets you design the perfect dock to suit your needs and grow or reconfigure at any time—quickly and easily. It's a snap to install. Just lay out the sections, bolt the couplers in place, and tighten down the bolts. EZ Dock's unique flotation design ensures maximum stability on the water—in any conditions.

THE PERFECT COUPLE

EZ Dock's couplers are made of recycled materials, and the nuts and bolts are constructed of a heavy-duty, rust-resistant composite to ensure strength and durability in even the harshest weather conditions.



CUSTOMIZABLE DESIGN



INNOVATIVE COUPLING

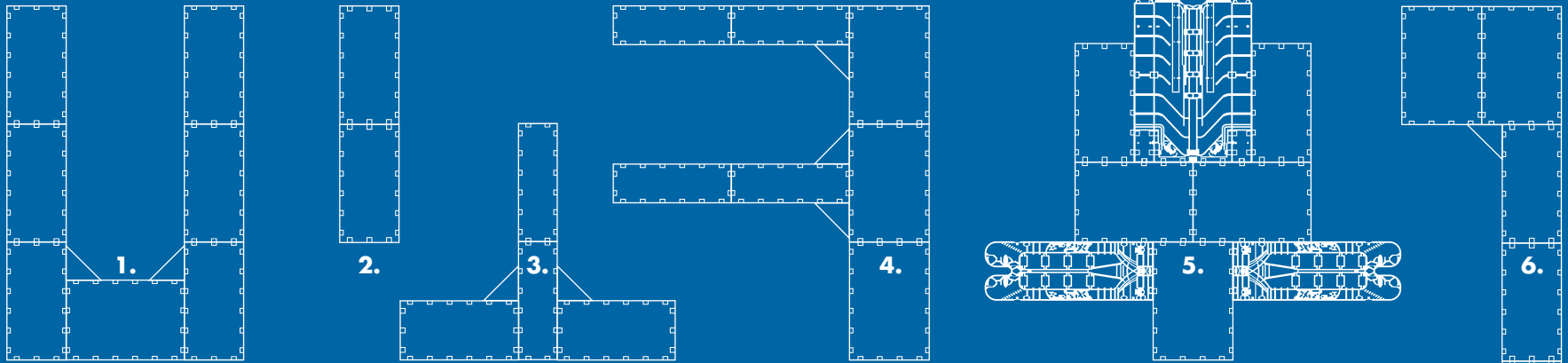

SAMPLE CONFIGURATIONS

- 1. U-shaped dock
- 2. Simple straight dock
- 3. T-shaped dock
- 4. Double-finger dock
- 5. Dock with 2 EZ Ports® and EZ BoatPort®
- 6. L-shaped dock with platform
- 7. F-shaped dock
- 8. Long L-shaped dock
- 9. Small rectangular platform
- 10. Dock with 2 EZ Ports®
- 11. Large rectangular platform
- 12. L-shaped dock

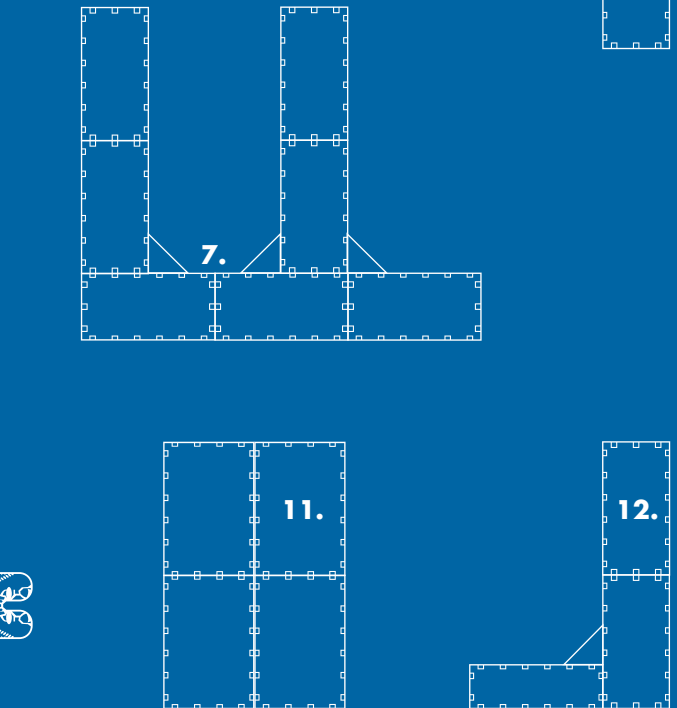

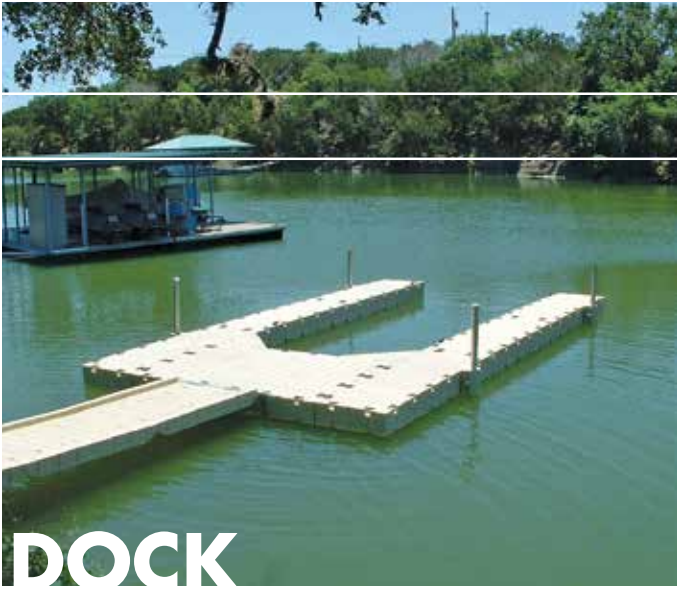

DESIGN YOUR DREAM DOCK



GET THE LOOK & FEATURES THAT ARE RIGHT FOR YOU

Our floating, modular, composite dock sections can be formed into a wide variety of custom configurations to perfectly suit your shoreline and your lifestyle. EZ Dock offers features and benefits that no other dock can match: unbeatable adaptability, exceptional performance in rough water, superior strength and durability, virtually no upkeep, universal accessibility, and easy installation. From simple straight-dock designs to complex configurations featuring multiple boat ports and platforms, EZ Dock makes it easy to create just what your family needs.

Visit the EZ Designer® Configuration Tool on our website at www.EZ-DOCK.com.
Need help designing your EZ Dock?
Call us at 1-800-654-8168.

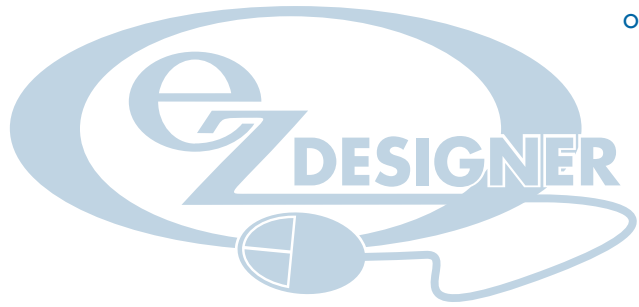

WHY WAIT? OUR DISTRIBUTORS HAVE MOST ITEMS IN STOCK AND READY FOR IMMEDIATE DELIVERY.



Details and specifications for dock sections can be found on page 25.



EZ Port® revolutionized docking and launching with the original, drive-on PWC lift. The industry leader, EZ Port® is the simplest and most durable drive-on, push-off method of dry-docking. The raised bow stop helps prevent drivers from overshooting, and there is no winching, cranking, pumping or hoisting needed.

The self-floating EZ Port® moves with changing water levels and helps protect your watercraft from damage caused by wind or waves, and it includes foot space on the sides and front for easy access. EZ Port® is so simple to use, even beginner PWC operators will find boarding and launching a breeze.

EZ PORT® FEATURES:

- Adjustable rollers adapt to a number of different PWC brands and hull designs
- Bulkhead safely prevents overshooting
- Three-sided accessibility
- Wide variety of anchoring options
- Compatible with all dock sections including platforms, landings and walkways

ONE PWC OR MULTIPLE? START WITH ONE AND EASILY ADD MORE AS YOUR FLEET GROWS.

EZ PORT MAX® 2i WITH SPLIT ENTRY



EZ PORT MAX®



EZ PORT MAX® WITH INTEGRATED BOW



GOOD TO GROW



EZ PORT MAX® INLINE



EZ PORT® 3



EZ PORT MAX® 2i



CHOOSE THE EZ PORT® THAT SUITS YOUR PWC REQUIREMENTS, DOCK LAYOUT & BUDGET

- **EZ Port MAX® 2i** — Our patented top-of-the-line, self-centering model features a split entry and self-adjusting rollers that make loading and unloading smooth and effortless. Ideal for larger PWC's.
- **EZ Port MAX®** — Our MAX ports (single, multiple or multiple inline) feature smooth-gliding rollers for easy, no-impact loading. Ideal for beginning PWC drivers.
- **EZ Port® 3** — Our original drive-up, dry-docking port has height-adjustable keel rollers. Ideal for older-model PWC's and rental agencies.

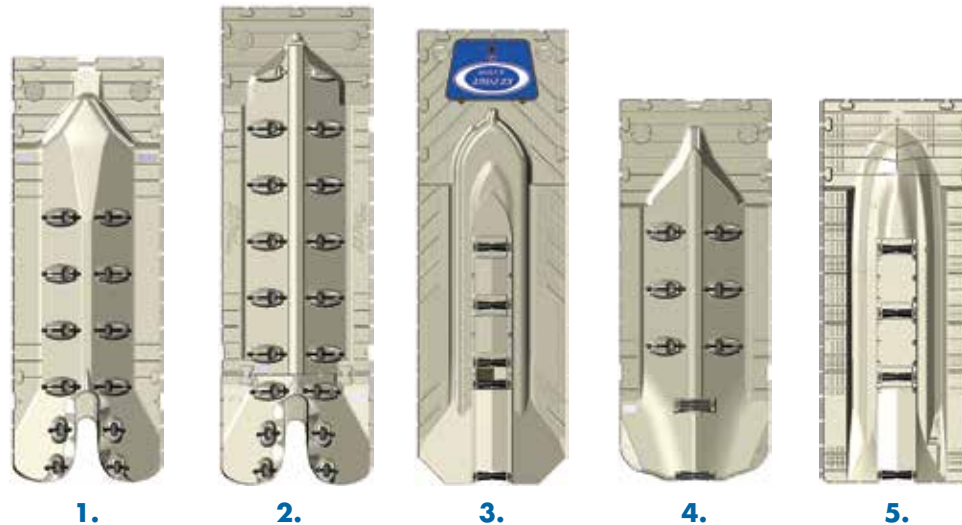

An **extension** is available for EZ Port MAX® 2, allowing for easy expansion and use with larger PWC's.

EZ Port® is the industry's simplest and most durable drive-on, push-off method of dry docking. We make it easy to spend less time docking and more time having fun.

FIND THE EZ PORT® THAT'S RIGHT FOR YOU.

	MODEL	SIZE (L x W x H)	WEIGHT	FLOTATION CAPACITY	PART #
1.	EZ Port MAX® 2i <i>Most port for your pocketbook!</i>	168" x 60" x 15" 4.27 m x 1.5 m x 38 cm	350 lbs. 159 kg	1,700 lbs. 771 kg	206036PW
2.	EZ Port MAX® 2	188" x 60" x 15" 4.7 m x 1.5 m x 38 cm	490 lbs. 222 kg	1,700 lbs. 771 kg	206034PW
3.	EZ Port® & Stow	184" x 60" x 15" 4.7 m x 1.5 m x 38 cm	520 lbs. 236 kg	1,450 lbs. 658 kg	206016PW
4.	EZ Port MAX®, Integrated Bow	149" x 60" x 15" 3.8 m x 1.5 m x 38.1 cm	320 lbs. 145 kg	1,380 lbs. 626 kg	206032PW
5.	EZ Port® 3	151" x 60" x 15" 3.8 m x 1.5 m x 38 cm	280 lbs. 127 kg	1,300 lbs. 590 kg	206013PW

EZ PORT MAX® SYSTEM | FOR TANDEM INLINES & TIGHT SLIP SPACES



IDEAL FOR TIGHT SLIP SPACES

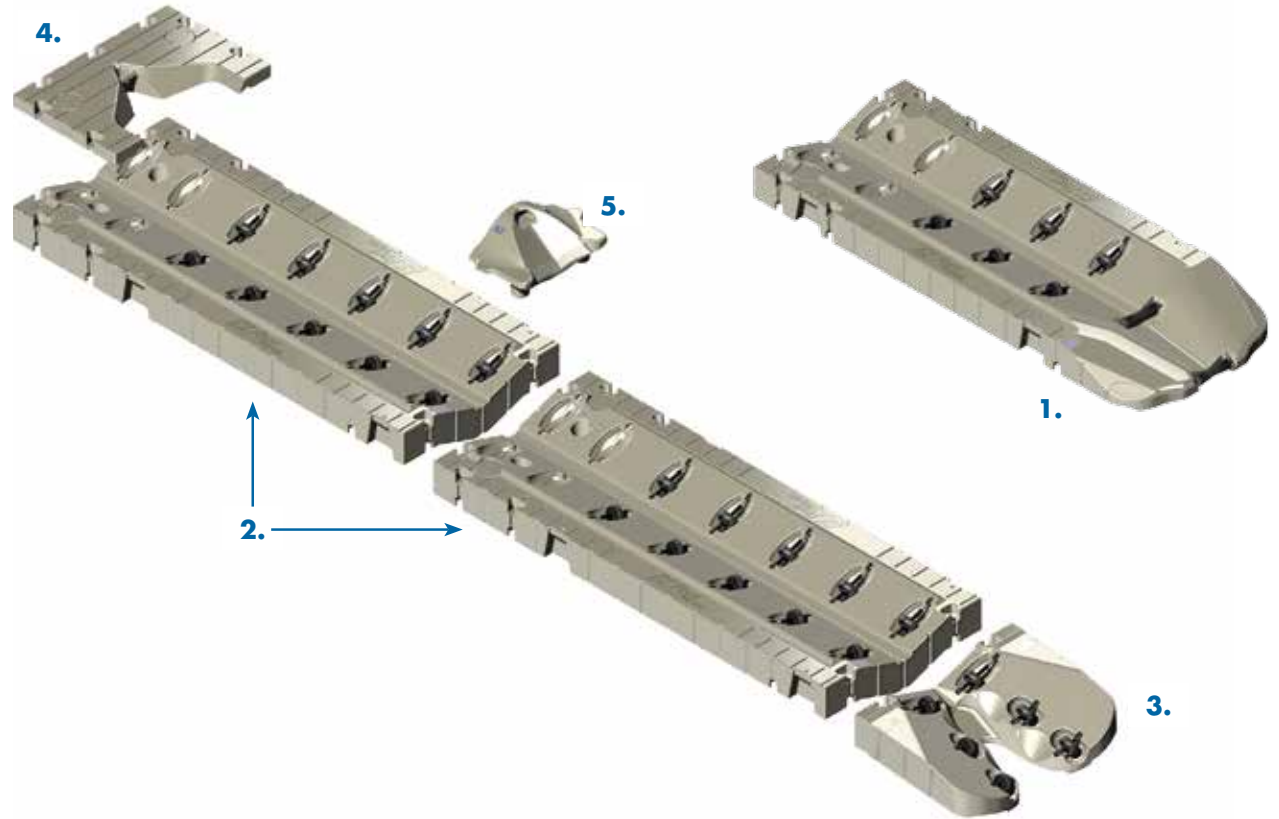

THE EZ PORT MAX® SYSTEM FOR MULTIPLE PWC'S

	MODEL	SIZE (L x W x H)	WEIGHT	FLOTATION CAPACITY	PART #
1.	EZ Port MAX® Entry	149" x 60" x 11" 3.78 m x 1.5 m x 28 cm	315 lbs. 142.8 kg	1,380 lbs. 626 kg	206030PW
2.	EZ Port MAX® Extension	146" x 60" x 11" 3.71 m x 1.5 m x 28 cm	328 lbs. 148.8 kg	1,400 lbs. 635 kg	206031PW
3.	EZ Port MAX® Easy-Lift Entry	60" x 42" x 15" 1.5 m x 1.1 m x 38.1 cm	95 lbs. 43 kg	400 lbs. 182 kg	206033EX
4.	EZ Port MAX® Full Bow Section	39" x 60" x 10" 1 m x 1.5 m x 25.4 cm	60 lbs. 27.2 kg	—	206025BS
5.	EZ Port MAX® Small Bow Section	33" x 10" x 16" .83 m x 2.54 cm x 40.6 cm	12 lbs. 5.4 kg	—	206027BS



Keeping your boat high and dry has never been so easy. The EZ BoatPort® is a simple and stable drive-on, drive-off method of docking for boats in a wide range of sizes up to 5,000 lbs.

Removable and changeable bunks can accommodate hull shapes from flat-bottoms to deep-Vs, making this the perfect choice for boats including skiffs, fishing boats and jet boats. The EZ BoatPort® is also available with side extensions for additional walk-around room and access to the sides of your boat for cleaning, maintenance and covering.

EZ BOATPORT® FEATURES:

- Configurations to fit multiple boats shapes and sizes
- Dry storage to extend the life of your boat
- Self-floating chambers that move with the changing water levels
- Works with existing floating or fixed docks
- No winching, cranking or hoisting

SAY GOODBYE TO THE SCUM LINE. KEEPING YOUR BOAT CLEAN JUST GOT A WHOLE LOT EASIER.

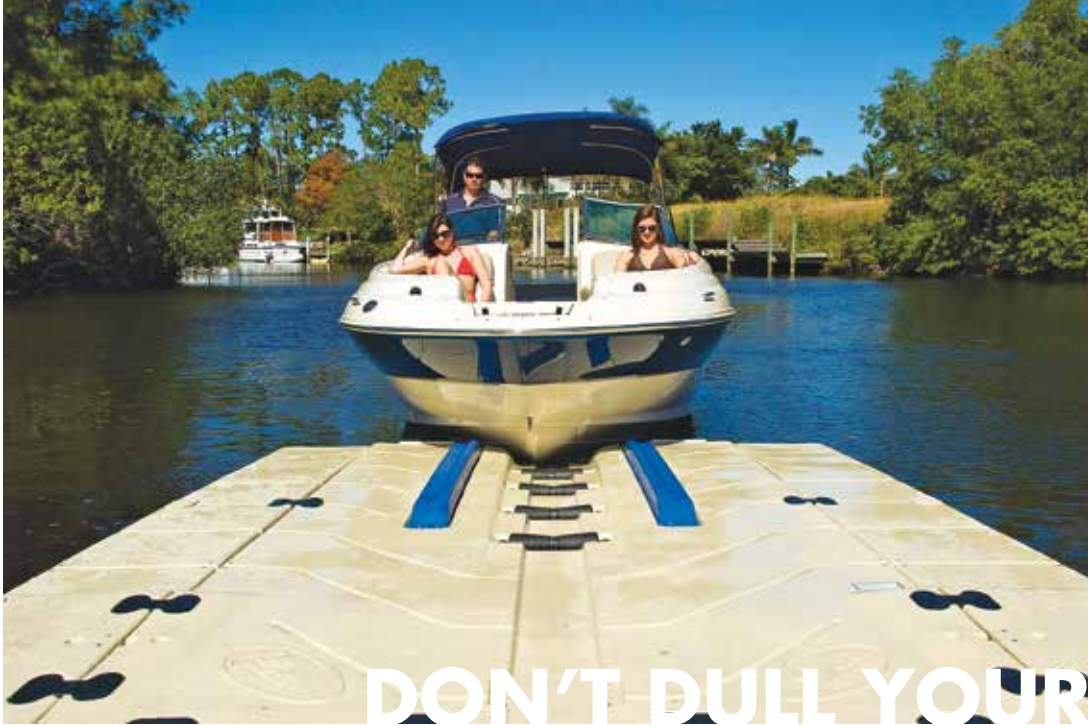

ADD-ON FEATURES:

- Two skid bunk options to fit a variety of hull shapes and sizes
- Up to three additional keel rollers for longer boats
- Supplemental flotation kit for added buoyancy
- Optional side extensions for additional walk-around room
- Flip-up front cleat to secure the boat to the port



DON'T DULL YOUR HULL

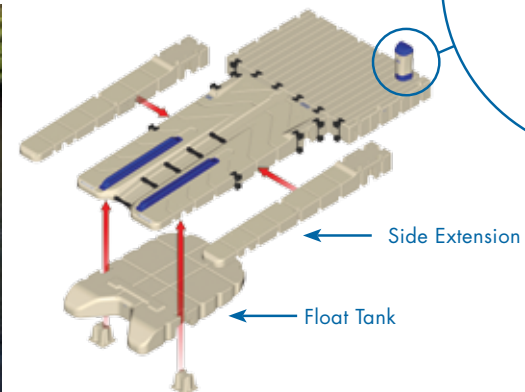

! Available with a **Float Tank** and **Air-Assist Pump** for a lifting capacity of up to 5,000 lbs. Choose from Manual Pump, Solar Pump, Remote Pump, European Pump, and Solar Remote.

Details and specifications for EZ BoatPorts® can be found on page 24.



The EZ Pontoon Lift offers the same convenience of our drive-on EZ BoatPort®—but it's specially designed for your pontoon. Two models are available: PL2000 for standard pontoon boats up to 2,000 lbs. and PL3500 for pontoon boats up to 3,500 lbs.

EZ PONTOON LIFT FEATURES:

- Versatile mounting options for multiple installation methods
- Durable marine-grade materials
- Modular system so you can easily expand or reconfigure your boatlift/dock by simply adding components
- Safe and easy-to-use platform design without any open areas or exposed metal
- Can be used with standard EZ Dock, traditional floating or fixed docks
- Provides stable porting in strong currents or windy conditions

PONTOON, BOAT & PWC? WITH EZ DOCK, YOU HAVE THE PERFECT PLACE FOR ALL OF THEM.



AIR-ASSIST PUMP

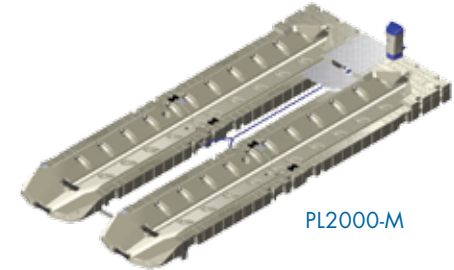

PL2000-M



PL3500-S

WE FLOAT YOUR BOAT

Details and specifications for EZ Pontoon Lifts can be found on page 25.



The EZ Launch® System is the safe, easy and ADA-compliant way to launch and dock kayaks and canoes. Great for people with disabilities, children or seniors. Users will feel confident transferring into their watercrafts independently and securely, and launching with stability and ease.

EZ LAUNCH® FEATURES:

- Guide rails for easy access in and out of the water
- Launch rollers for easy movement of the watercraft
- Transfer bench with two heights for easy transfer from wheelchairs
- Transfer slide boards with two heights for differing watercraft sizes
- Railing system for slide board stabilization and transfer support for easy side movement
- Floating platform that adjusts to changing water levels



UNIVERSAL ACCESSIBILITY

A first in the industry, the EZ Launch® Accessible Transfer System for kayakers and canoes provides individuals with disabilities accessibility that exceeds the minimum requirements of the Americans with Disabilities Act (ADA). The easy-to-use transfer bench and transfer slide boards allow users to simply sit, slide over and drop down, then use the side rails to pull off or back on. The customizable system is also ideal for children, seniors, or anyone needing extra stability launching and docking a kayak or canoe.



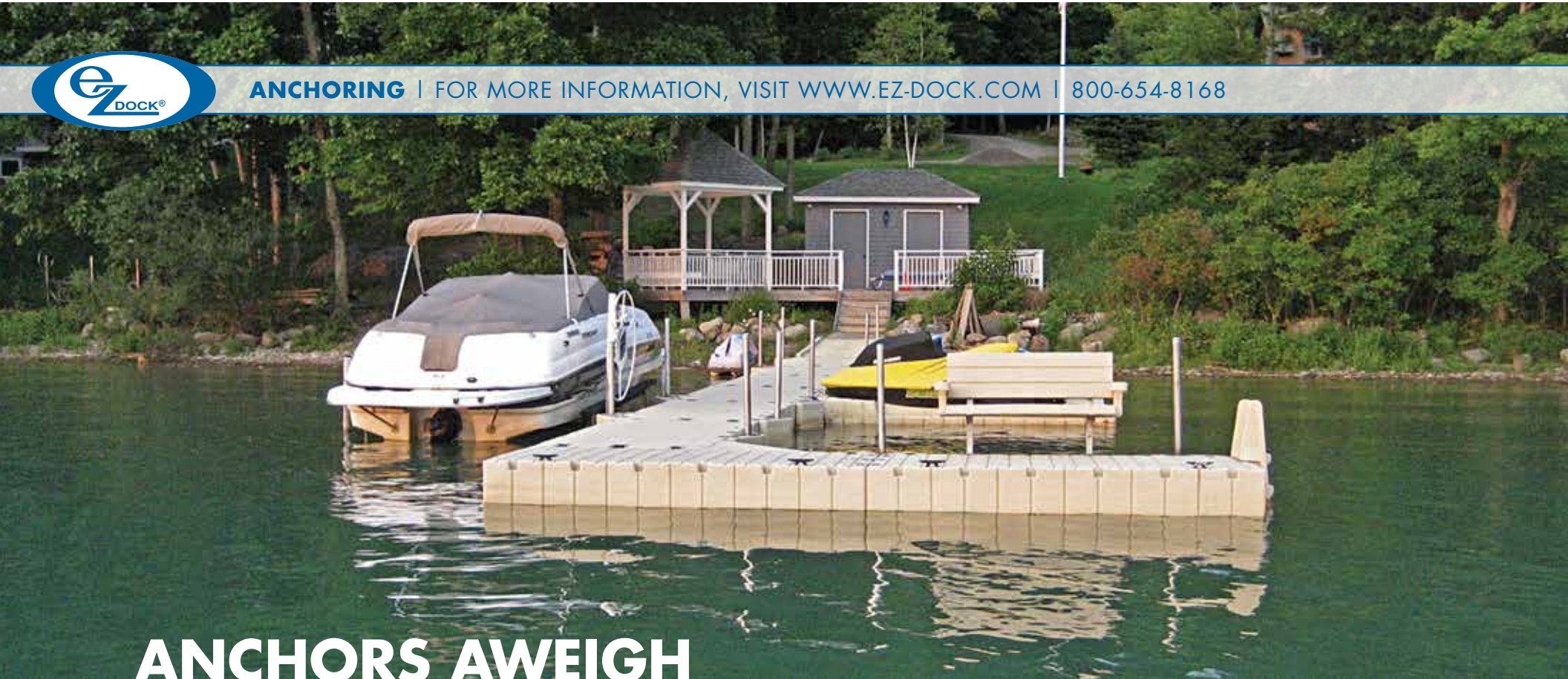

ANCHORS AWEIGH



1.



2.



3.



4.



5.



6.



7.



8.



9.



10.

FAST, EASY & STURDY: JUST SET IT AND FORGET IT.

Once you've created your EZ Dock, you'll need to select an anchoring system to work with your existing piling or your new installation. Our wide-variety of anchoring components can accommodate most water conditions and bottoms (deep, shallow, rough, muddy or sandy) and are simple to install. EZ Dock anchoring products are made from long-lasting, durable materials that can accommodate standard or heavy-duty use. Your local dealer can help you select the anchoring system that's right for your location. **Call us at 1-800-654-8168.**



1. PIPE AUGERS

100255 or 100355

Nut and bolt auger for drilling and setting pipe in lakes, rivers or ocean bottoms. Pipe sold separately.

2. ADAPTER HINGE

100750 or 100750SS

Reversible hinge for bolting EZ Port® PWC lifts or EZ Dock sections to other types of floating docks. Set of 2.

3. STIFF-ARM (HEAVY-DUTY)

800099

Anchor to shoreline abutment or shoreline post with our heavy-duty stiff-arm. Light-duty stiff-arm bracket also available.

4. PIPE BRACKET (HEAVY-DUTY)

215250 or 215350

Heavy-duty polyethylene pipe bracket allows docks to adjust to changing water levels.

5. PIPE BRACKET (STANDARD-DUTY)

135250 or 135350

Standard-duty polyethylene bracket provides ample anchoring for EZ Port® PWC lifts or for smaller docks in moderate conditions.

6. PIPE STAND-OFF BRACKET

1051000

Polyurethane bracket attaches top of pipe to stationary docks. Fits pipe from 2.5" to 3.5" O.D.

7. DEADWEIGHT BRACKET (HEAVY-DUTY)

210350 with 100725P Insert

Add a deadweight insert to our heavy-duty polyethylene pipe bracket to anchor docks in deep water or over rocky bottoms.

8. DEADWEIGHT WINCH INSERT

210350 with 100730 Winch Insert

Deadweight insert and cable winch added to our polyethylene pipe bracket allow easy dock adjustment for water fluctuations. Cable sold separately.

9. DEADWEIGHT BRACKET (STANDARD-DUTY)

100740 or 100740SS

For light-duty anchoring with chain and/or to attach 4" x 4" railing or mooring posts. Chain sold separately. Set of 2.

10. DEADWEIGHT STIFF ARM COMBO BRACKET

100700 or 800095-15

Combination bracket can be used with both EZ Dock's deadweight or Stiff-Arm anchoring system.

11. ADJUSTABLE PILING BRACKET

300800

Heavy-duty polyethylene bracket allows lateral position adjustment to attach to piles up to 18" in diameter.

12. PILING BRACKET & HOOP

100800 or 100812 (shown)

Mainframe piling bracket is pre-drilled for hoops from 4" to 24" wide. Includes connectors with nuts. Hoops sold separately.



11.



12.



1. SWIM LADDER
300260

2. DOCK SLIDE
300600

3. EZ STOW STORAGE BOX
300750

4. CORNER STORAGE BOX
300760

5. EZ FLOAT STEP LADDER
300270

6. POLYETHYLENE BENCH KIT
300970AL or 300965AL (w/o arms)

7. TIE-UP CLEAT
300100

8. 10" TIE-UP CLEAT
300110

9. CORNER GUSSET
300501

10. DOCK EDGING
400117

11. DOCK BUMPER
300180

12. DOCK WHEELS
900050

13. HARDWARE CONNECTOR MALE
201040SS

14. HARDWARE CONNECTOR FEMALE
201041SS

15. IN-WATER INSTALLATION TOOL
900010SS

MAKE IT YOUR OWN. CUSTOMIZE YOUR EZ DOCK SYSTEM TO GET EXACTLY WHAT YOU NEED.



ADD YOUR OWN SIGNATURE

With the EZ Dock modular system, you can add a wide variety of accessories including storage boxes, bumpers, cleats, benches, ladders and slides using our easy-to-use coupling system. Do you have a specialty item or piece of equipment that you want affixed to your dock? Simply use our hardware connectors to bolt it directly to the section you choose. It's that easy.

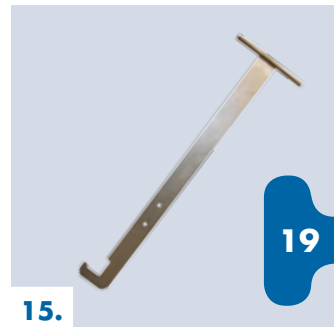



1.



2.



3.



4.



5.



6.



7.

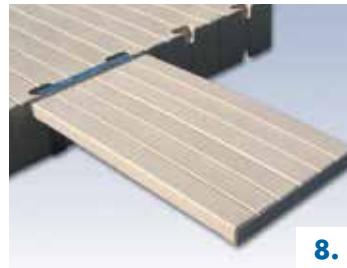

8.



EASY ACCESS

Engineered with the same technology and quality as our dock sections, EZ Dock gangways offer uncompromised durability and modular versatility. Gangways are manufactured from aluminum, wood or polyethylene.

1. GANGWAY (ALUMINUM)

G300308 to G300532

Features welded construction with an available ThruFlow™ decking walkway. Available in 3' & 5' widths and lengths from 8' to 32'.

2. GANGWAY (POLYETHYLENE)

400406 (6' section)

Shown at left with two 6' sections installed with the 12' Aluminum Tube Support Kit (401412) and optional 12' Hand Rail (400912).

3. GANGWAY ROLLER KIT

300300, 300400

Gangway Roller Kit allows end of gangway to adjust to changing water levels. PVC and galvanized steel roller available for 3' and 5' widths.

4. TRANSITION PLATE

G200350 or G200550

Gangway transition plate with ThruFlow™ decking creates a sturdy transition between shore grade and aluminum gangway.

5. HINGE TO FLOAT

G200360, G200450, G200560

Hinged bracket with hardware attaches gangway to shoreline dock.

6. TRANSITION KIT (POLYETHYLENE)

100717 (15") or 100718 (30")

Hinged polyethylene plate creates a smooth transition between EZ Dock or EZ Port® and another floating dock.

7. GANGPLANK MOUNTING KIT

100240, 100340 or 100600

Galvanized steel hinge bracket and hardware for wood walkways 24", 34", or 60" wide. Lumber not included.

8. PLANK GANGWAY (POLYETHYLENE)

200200

Hinged polyethylene panel creates a smooth transition between shore grade and deck surface.



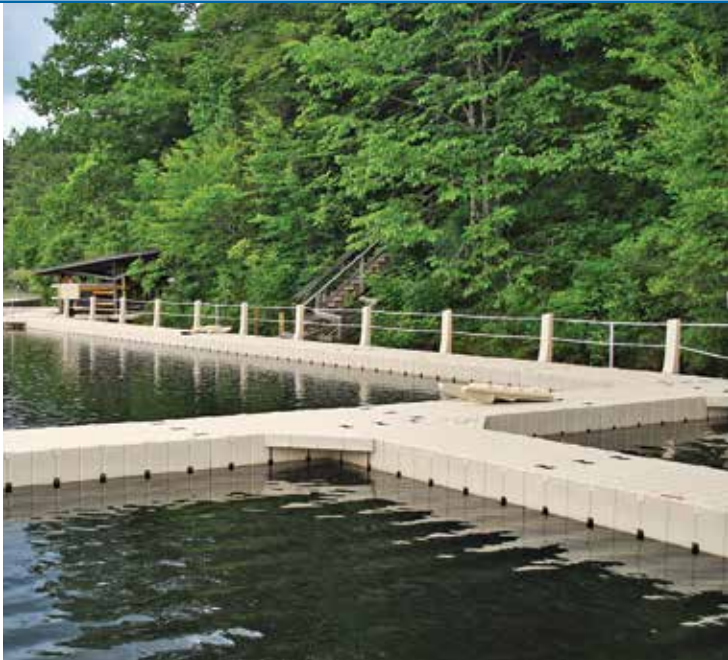

SAFE, SECURE & CODE-COMPLIANT

For commercial or residential use, EZ Dock modular railings conform to all States Organization for Boating Access (SOBA) and Americans with Disabilities Act (ADA) guidelines. Railing sections are available in a variety of lengths and profiles designed to provide safety and security with minimal obstruction.





ADDITIONAL APPLICATIONS | FOR MORE INFORMATION, VISIT WWW.EZ-DOCK.COM | 800-654-8168





INDUSTRIAL



FLEET DOCKS



FLOAT PLANE DOCKING



SAILING & YACHT CLUBS



CAMPS & RECREATION



FISHING TOURNAMENTS

YOU DREAM IT. WE'LL FLOAT IT.



SALES EVENTS



ROWING

EZ BOATPORT®

	MODEL	SIZE (W x L)	AREA	OPTIONS	FLOTATION CAPACITY	PART #
1.	EZ BoatPort® Standard	78" x 13'8" 2 m x 4 m	90 sq. ft. 8.4 m ²	Long or short bunks	2,000 lbs. 907 kg	BP2000*
2.	EZ BoatPort® with Side Extensions	118" x 13'8" 3.1 m x 4.3 m	140 sq. ft. 13.0 m ²	Long or short bunks	3,000 lbs. 1,361 kg	BP3000*
3.	EZ BoatPort® with Side Extensions & Large Platform	118" x 18'6" 3.1 m x 5.8 m	190 sq. ft. 17.7 m ²	Long or short bunks	3,000 lbs. 1,361 kg	BP3001*
4.	EZ BoatPort® with Float Tank & Air-Assist	78" x 18'6" 2 m x 5.8 m	124 sq. ft. 11.5 m ²	Long or short bunks air-assist unit options	4,000 lbs. 1,814 kg	BP4000**
5.	EZ BoatPort® with Float Tank and Air-Assist & Large Platform	78" x 23'5" 2 m x 7.3 m	156 sq. ft. 14.5 m ²	Long or short bunks air-assist unit options	4,000 lbs. 1,814 kg	BP4001**
6.	EZ BoatPort® with Side Extensions, Float Tank & Air-Assist	118" x 20'2" 3.1 m x 6.2 m	205 sq. ft. 19.1 m ²	Long or short bunks air-assist unit options	5,000 lbs. 2,268 kg	BP5000**
7.	EZ BoatPort® with Side Extensions, Float Tank, Air-Assist & Large Platform	118" x 23'5" 3.1 m x 7.3 m	240 sq. ft. 22.3 m ²	Long or short bunks air-assist unit options	5,000 lbs. 2,268 kg	BP5001**

* Package options include all additional rollers and choice of long or short bunks.

** Package options include all additional rollers, choice of long or short bunks and choice of manual, solar or remote-control pump unit.

NOTE: Because of the rotational molding process, weights and dimensions may vary.

* Supplemental flotation available to increase capacity for specific applications.

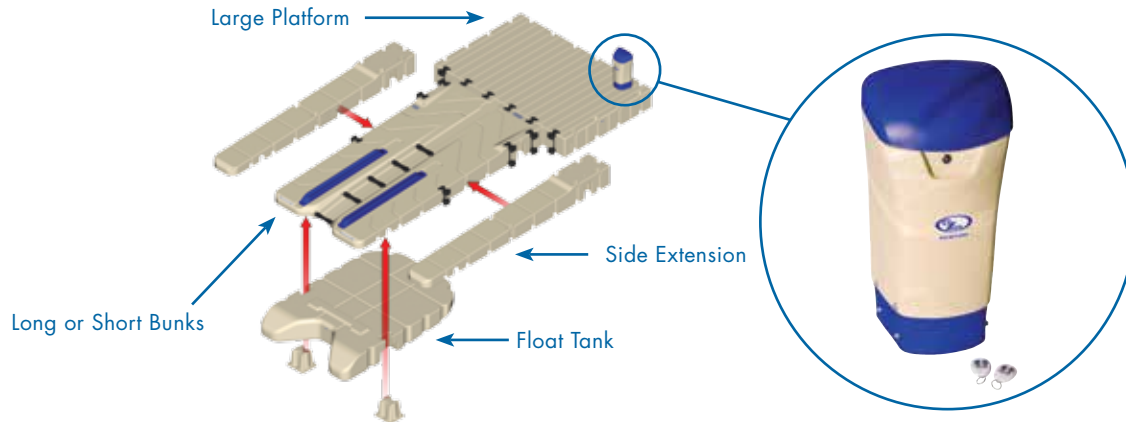
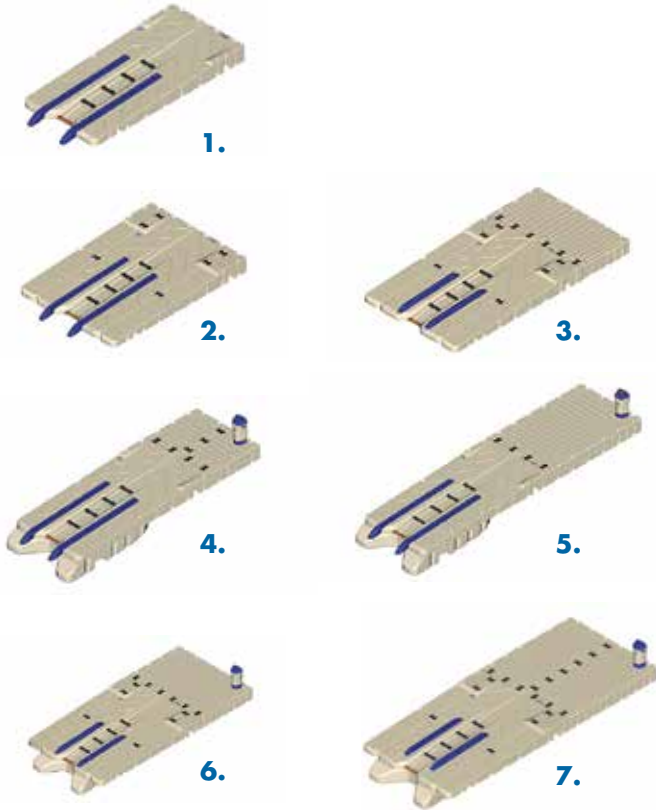

Available with a **Float Tank** and **Air-Assist Pump** for a lifting capacity of up to 5,000 lbs.

- Manual (110 volt AC)
- Solar Powered (12 volt DC)
- Remote Controlled (110 volt AC)
- European Manual (220 volt AC)
- Solar Powered Remote Controlled (12 volt DC)

DOCK SECTIONS

	DOCK SECTIONS	SIZE (W x L x H)	WEIGHT	FLOTATION CAPACITY*	PART #
1.	40" x 5' Dock	39" x 4' 8" x 14.625" 1 m x 1.5 m x 38 cm	95 lbs. 43 kg	1,000 lbs. 453.6 kg	204060
2.	40" Dock	39" x 9'9" x 14.625" 1 m x 3 m x 38 cm	180 lbs. 82 kg	2,000 lbs. 907.2 kg	204010
3.	60" Dock	58.5" x 9'9" x 14.625" 1.5 m x 3 m x 38 cm	270 lbs. 123 kg	3,000 lbs. 1,360.8 kg	206010
4.	80" Dock	78" x 9'9" x 14.625" 2 m x 3 m x 38 cm	365 lbs. 166 kg	4,000 lbs. 1,814.4 kg	208010
5.	100" Dock	92" x 6' 5" x 14.625" 2 m x 2 m x 38 cm	310 lbs. 140 kg	3100 lbs. 1,406 kg	208008
6.	Half Hex Dock	58.5" x 9'9" x 14.625" 1.5 m x 3 m x 38 cm	210 lbs. 95.3 kg	2,000 lbs. 907.2 kg	260120
7.	Corner Gusset	—	22 lbs.	—	300501

NOTE: Because of the rotational molding process, weights and dimensions may vary.

* Supplemental flotation available to increase capacity for specific applications.



PONTOON LIFTS

	MODEL	SIZE*	WEIGHT	FLOTATION CAPACITY	PART #
1.	EZ Pontoon Lift (up to 2,000 lbs.)	294.3" x variable width x 14-5/8" 747.7 cm x variable width x 37.1 cm	1,700 lbs. 771.1 kg	2,000 lbs. 907 kg	PL2000*
2.	EZ Pontoon Lift (up to 3,500 lbs.)	294.3" x variable width x 14-5/8" 747.7 cm x variable width x 37.1 cm	2,000 lbs. 907 kg	3,500 lbs. 1,587 kg	PL3500*

NOTE: Because of the rotational molding process, weights and dimensions may vary.

Overall width depends on the pontoon center spacing and overall deck width.

*Package options include choice of manual, solar or remote-control pump unit.

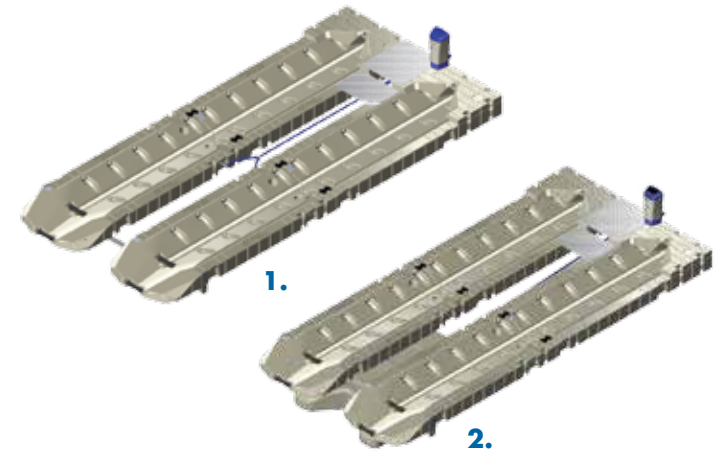

TRANSOM MOTOR STOP

The Transom Motor Stop attaches to the Pontoon Lift's Underwater Finger Stiffener to stop the boat when it's fully docked on the Lift. This optional kit is fully adjustable and comes complete with a wear plate and all attachment hardware.





INTERNATIONAL DISTRIBUTION | FOR MORE INFORMATION, VISIT WWW.EZ-DOCK.COM | 800-654-8168

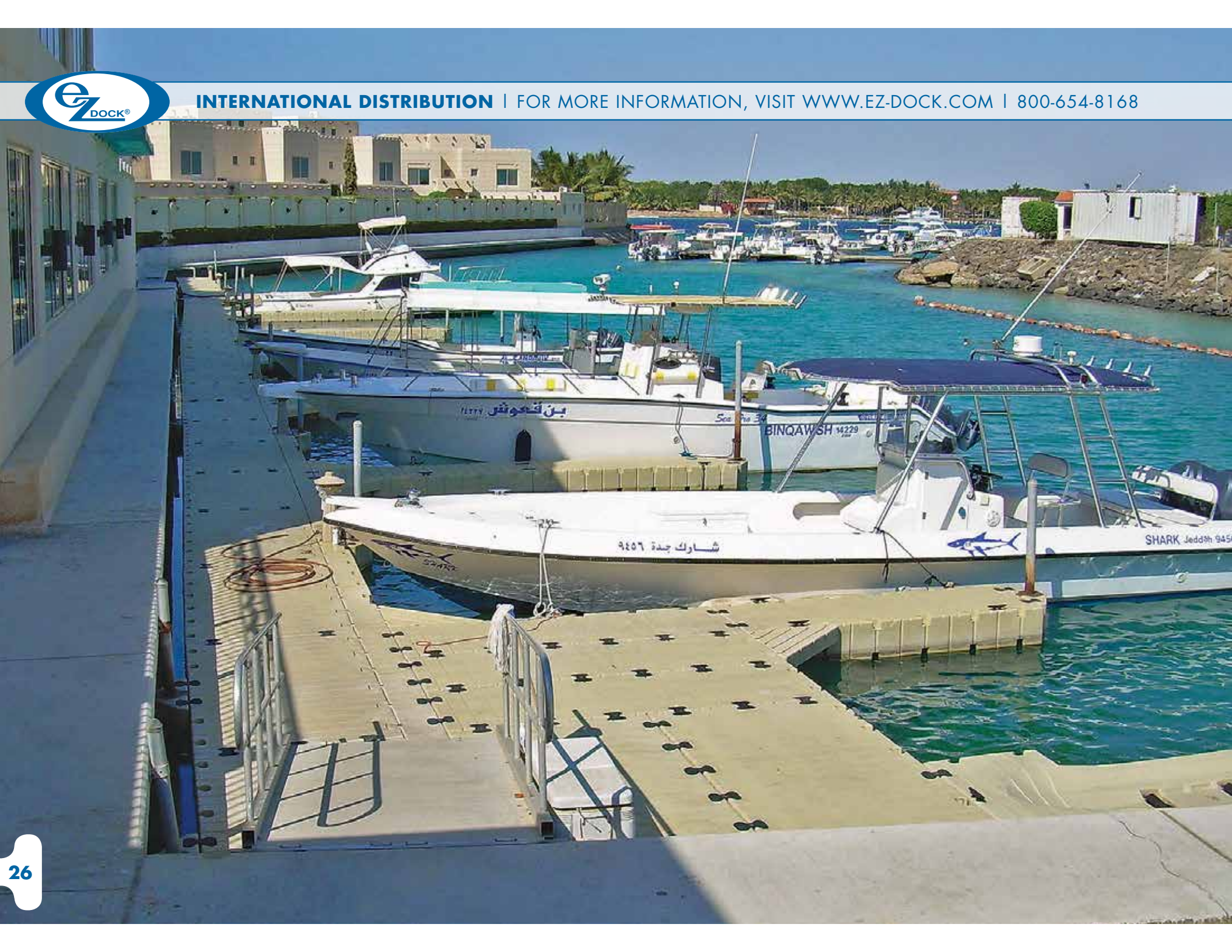

A world map with various regions highlighted in different shades of blue and grey. North America, South America, and parts of Europe and Africa are in a medium blue. Other parts of Europe, Africa, and Asia are in a lighter blue. Australia and parts of Asia are in a greyish-blue. The rest of the world is in white.

WORLDWIDE DISTRIBUTION NETWORK

EZ Dock is the world's market-leading floating dock and PWC lift manufacturer. Engineered for low maintenance and durability, EZ Dock is the most stable floating dock system on the market. From commercial events to personal recreation, EZ Dock's modular dock designs, boat lifts, PWC lifts and dock accessories make it easy to create your perfect waterfront setting.

Try our EZ Designer® Configuration Tool on our website at www.EZ-DOCK.com to create your perfect dock, and call us to find your local EZ Dock dealer.

US/CANADA 1-800-654-8168

EUROPE +46 (0) 380 47 300

INTERNATIONAL +1-417-235-2223

THE BEST IN THE INDUSTRY

EZ Dock's global network of highly trained and knowledgeable dealers and distributors are ready to help you design the perfect dock.

Large or small, we can make your waterfront dreams a reality.

**VISIT WWW.EZ-DOCK.COM
OR CALL US AT 1-800-654-8168.**

DESIGN-A-DOCK

Draw your dream dock here:

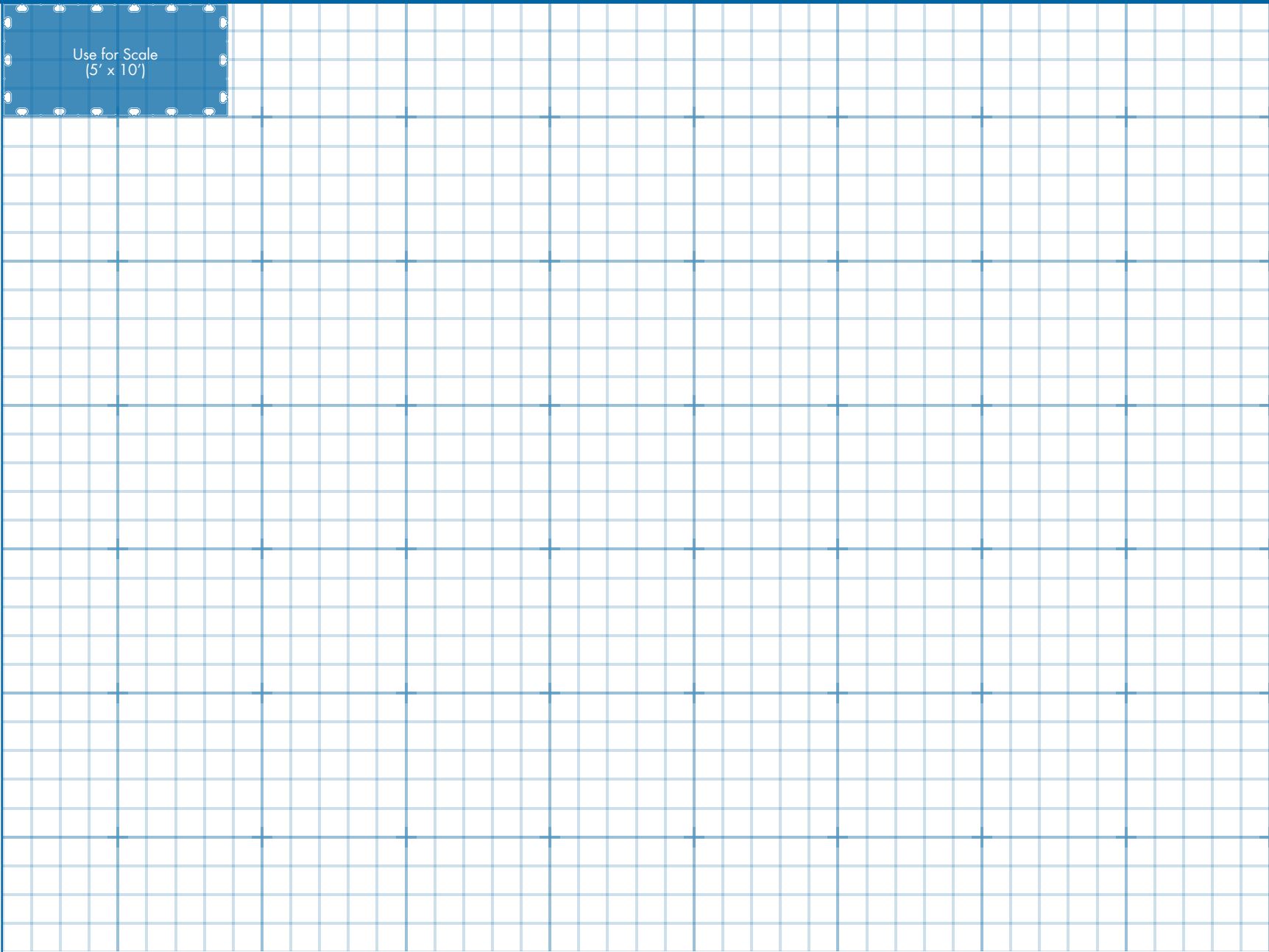
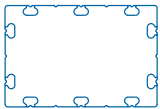
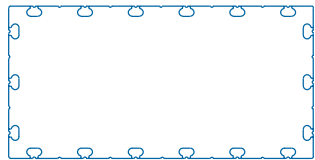
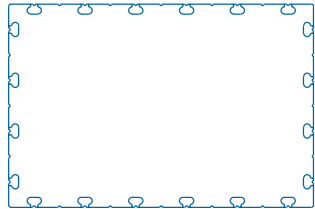
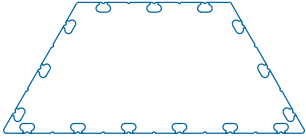
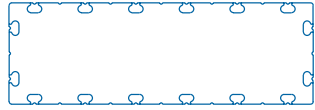
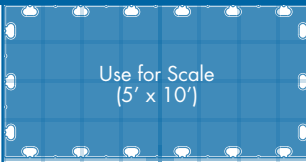

EZ DOCK |

A DIVISION OF PLAYPOWER
878 HWY. 60 • MONETT, MO • USA 65708

| WWW.EZ-DOCK.COM |

1-800-654-8168

EZ Dock may introduce new colors, products, accessories and options throughout the year. Specifications and products listed are subject to change without notice. Some products may be shown with additional or optional equipment not available through EZ Dock. Specifications may vary for international shipments. Please check with your local dealer for more information. EZ Dock is a product of the U.S.A.
NOTE: Because of the rotational molding process, actual weights and dimensions may vary.